



# Aerocore Chainsaw



## Owner's Manual

Masport Aerocore Chainsaw

### Important

**Please read these instructions carefully before assembly, to reduce risk of fire, burn hazard or other injury.  
Keep these instructions in a safe place for future use.**

This manual covers the Masport Aerocore Chainsaw











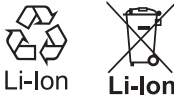

**Do not operate this machine before it has been assembled correctly and you have read and understood these instructions.**

**Keep the instructions in a safe place for future use.**

## Contents

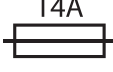
Symbols	2
General Power Tool Safety Warnings	3
Safety warning for Battery Pack	4
Safety Warning for Battery Charger	4
Additional Safety warnings for Cordless Chainsaw	4
Product Specifications	6
Product Diagram	6
Assembly	6
Operation	6
Maintenance	8
Storage	8
Troubleshooting	8

	To reduce the risk of injury, user must read instruction manual.
	Wear ear protection
	Wear eye protection
	Wear dust mask
	Always use chainsaw two-handed

	Beware of chain saw kickback and avoid contact with bar tip
	Do not expose to rain
	RCM symbol
	Li-Ion battery. This product has been marked with a symbol relating to 'separate collection' for all battery packs and battery pack. It will then be recycled or dismantled in order to reduce the impact on the environment. Battery packs can be hazardous for the environment and for human health since they contain hazardous substances.
	Do not burn
	Batteries may enter water cycle if disposed improperly, which can be hazardous for ecosystem. Do not dispose of waste batteries as unsorted municipal waste.
	For indoor use only
	Read the operator's manual.
	Fuse
	Positive Terminal
	Negative Terminal
	Double Insulation

## General Power Tool Safety Warnings



**WARNING** Read all safety warnings and all instructions. Failure to follow the warnings and instructions may result in electric shock, fire and/or serious injury. Save all warnings and instructions for future reference. The term “power tool” in the warnings refers to your mains-operated (corded) power tool or battery-operated (cordless) power tool.

### 1) Work area safety

- a) **Keep work area clean and well lit.** *Cluttered or dark areas invite accidents.*
- b) **Do not operate power tools in explosive atmospheres, such as in the presence of flammable liquids, gases or dust.** *Power tools create sparks which may ignite the dust or fumes.*
- c) **Keep children and bystanders away while operating a power tool.** *Distractions can cause you to lose control.*

### 2) Electrical safety

- a) **Power tool plugs must match the outlet. Never modify the plug in any way. Do not use any adapter plugs with earthed (grounded) power tools.** *Unmodified plugs and matching outlets will reduce risk of electric shock.*
- b) **Avoid body contact with earthed or grounded surfaces, such as pipes, radiators, ranges and refrigerators.** *There is an increased risk of electric shock if your body is earthed or grounded.*
- c) **Do not expose power tools to rain or wet conditions.** *Water entering a power tool will increase the risk of electric shock.*
- d) **Do not abuse the cord. Never use the cord for carrying, pulling or unplugging the power tool. Keep cord away from heat, oil, sharp edges or moving parts.** *Damaged or entangled cords increase the risk of electric shock.*
- e) **When operating a power tool outdoors, use an extension cord suitable for outdoor use.** *Use of a cord suitable for outdoor use reduces the risk of electric shock.*
- f) **If operating a power tool in a damp location is unavoidable, use a residual current device (RCD) protected supply.** *Use of an RCD reduces the risk of electric shock.*

### 3) Personal safety

- a) **Stay alert, watch what you are doing and use common sense when operating a power tool. Do not use a power tool while you are tired or under the influence of drugs, alcohol or medication.** *A moment of inattention while operating power tools may result in serious personal injury.*
- b) **Use personal protective equipment. Always wear eye protection.** *Protective equipment such as dust mask, non-skid safety shoes, hard hat, or hearing protection used for appropriate conditions will reduce personal injuries.*
- c) **Prevent unintentional starting. Ensure the switch is in the off-position before connecting to power source and/or battery pack, picking up or carrying the tool.** *Carrying power tools with your finger on the switch or energising power tools that have the switch on invites accidents.*
- d) **Remove any adjusting key or wrench before turning the power tool on.** *A wrench or a key left attached to a rotating part of the power tool may result in personal injury.*

- e) **Do not overreach. Keep proper footing and balance at all times.** *This enables better control of the power tool in unexpected situations.*
- f) **Dress properly. Do not wear loose clothing or jewellery. Keep your hair, clothing and gloves away from moving parts.** *Loose clothes, jewellery or long hair can be caught in moving parts.*
- g) **If devices are provided for the connection of dust extraction and collection facilities, ensure these are connected and properly used.** *Use of these devices can reduce dust-related hazards.*
- h) **Do not let familiarity gained from frequent use of tools allow you to become complacent and ignore tool safety principles.** *A careless action can cause severe injury within a fraction of a second.*

### 4) Power tool use and care

- a) **Do not force the power tool. Use the correct power tool for your application.** *The correct power tool will do the job better and safer at the rate for which it was designed.*
- b) **Do not use the power tool if the switch does not turn it on and off.** *Any power tool that cannot be controlled with the switch is dangerous and must be repaired.*
- c) **Disconnect the plug from the power source and/or the battery pack from the power tool before making any adjustments, changing accessories, or storing power tools.** *Such preventive safety measures reduce the risk of starting the power tool accidentally.*
- d) **Store idle power tools out of the reach of children and do not allow persons unfamiliar with the power tool or these instructions to operate the power tool.** *Power tools are dangerous in the hands of untrained users.*
- e) **Maintain power tools. Check for misalignment or binding of moving parts, breakage of parts and any other condition that may affect the power tool's operation. If damaged, have the power tool repaired before use.** *Many accidents are caused by poorly maintained power tools.*
- f) **Keep cutting tools sharp and clean.** *Properly maintained cutting tools with sharp cutting edges are less likely to bind and are easier to control.*
- g) **Use the power tool, accessories and tool bits etc. in accordance with these instructions, taking into account the working conditions and the work to be performed.** *Use of the power tool for operations different from those intended could result in a hazardous situation.*
- h) **Keep handles and grasping surfaces dry, clean and free from oil and grease.** *Slippery handles and grasping surfaces do not allow for safe handling and control of the tool in unexpected situations.*

### 5) Battery tool use and care

- a) **Recharge only with the charger specified by the manufacturer.** *A charger that is suitable for one type of battery pack may create a risk of fire when used with another battery pack.*
- b) **Use power tools only with specifically designated battery packs.** *Use of any other battery packs may create a risk of injury and fire.*
- c) **When battery pack is not in use, keep it away from other metal objects, like paper clips, coins, keys, nails, screws or other small metal objects, that can make a connection from one terminal to another.** *Shorting the battery terminals together may cause burns or a fire.*
- d) **Under abusive conditions, liquid may be ejected from the battery; avoid contact. If contact accidentally occurs,**

flush with water. If liquid contacts eyes, additionally seek medical help. Liquid ejected from the battery may cause irritation or burns.

e) Do not use a battery pack or tool that is damaged or modified. Damaged or modified batteries may exhibit unpredictable behaviour resulting in fire, explosion or risk of injury.

f) Do not expose a battery pack or tool to fire or excessive temperature. Exposure to fire or temperature above 130 °C may cause explosion.

g) Follow all charging instructions and do not charge the battery pack or tool outside the temperature range specified in the instructions. Charging improperly or at temperatures outside the specified range may damage the battery and increase the risk of fire.

## 6) Service

a) Have your power tool serviced by a qualified repair person using only identical replacement parts. This will ensure that the safety of the power tool is maintained.

b) Never service damaged battery packs. Service of battery packs should only be performed by the manufacturer or authorized service providers.

---

## Safety warning for Battery Pack

---

a) Do not dismantle, open or shred cells or battery pack.

b) Do not short-circuit a battery pack. Do not store battery packs haphazardly in a box or drawer where they may short-circuit each other or be short-circuited by conductive materials. When battery pack is not in use, keep it away from other metal objects, like paper clips, coins, keys, nails, screws or other small metal objects, that can make a connection from one terminal to another. Shorting the battery terminals together may cause burns or a fire.

c) Do not expose battery pack to heat or fire. Avoid storage in direct sunlight.

d) Do not subject battery pack to mechanical shock.

e) In the event of battery leaking, do not allow the liquid to come into contact with the skin or eyes. If contact has been made, wash the affected area with copious amounts of water and seek medical advice.

f) Seek medical advice immediately if a cell or battery pack has been swallowed.

g) Keep battery pack clean and dry.

h) Wipe the battery pack terminals with a clean dry cloth if they become dirty.

i) Battery pack needs to be charged before use. Always refer to this instruction and use the correct charging procedure.

j) Do not maintain battery pack on charge when not in use.

k) After extended periods of storage, it may be necessary to charge and discharge the battery pack several times to obtain maximum performance.

l) Battery pack gives its best performance when it is operated at normal room temperature (20 °C ± 5 °C).

m) When disposing of battery packs, keep battery packs of different electrochemical systems separate from each other.

n) Recharge only with the charger specified by Masport. Do not use any charger other than that specifically provided for use with the equipment. A charger that is suitable for one type of battery pack may create a risk of fire

when used with another battery pack.

o) Do not use any battery pack which is not designed for use with the equipment.

p) Keep battery pack out of the reach of children.

q) Retain the original product literature for future reference.

r) Remove the battery from the equipment when not in use.

s) Dispose of properly.

t) Do not mix cells of different manufacture, capacity, size or type within a device.

u) Do not remove battery pack from its original packaging until required for use.

v) Observe the plus (+) and minus (-) marks on the battery and ensure correct use.

---

## Safety warning for Battery Charger

---

1. Before charging, read the instructions.
2. For charge Li-ion battery pack only.
3. Do not charge a leaking battery.
4. Do not use chargers for works other than those for which they are designed.
5. Before charging, ensure your charger is matching the local AC supply.
6. The charging device must be protected from moisture.
7. Do not use the charging device outdoors.
8. Do not short out the contacts of battery or charger.
9. Respect the polarity "+/-" when charging.
10. Do not open the unit and keep it out of the reach of children.
11. Do not charge the batteries of other manufactures or ill-suited models.
12. Ensure that the connection between the battery charger and battery is correctly positioned and is not obstructed by foreign bodies.
13. Keep battery charger's slots free of foreign objects and protect against dirt and humidity. Store in a dry and frost-free place.
14. When charging batteries, ensure that the battery charger is in a well-ventilated area and away from inflammable materials. Batteries can get hot during charging. Do not overcharge any batteries. Ensure that batteries and chargers are not left unsupervised during charging.
15. Do not recharge non-rechargeable batteries, as they can overheat and break.
16. Longer life and better performance can be obtained if the battery pack is charged when the air temperature is between 18°C and 24°C. Do not charge the battery pack in air temperatures below 0°C, or above 40°C. This is important as it can prevent serious damage to the battery pack.
17. Charge only battery pack of the same model provided by Masport and of models recommended by Masport.

---

## Additional safety warnings for chainsaw

---

 **WARNING** Read all safety warnings and all instructions. Failure to follow the warnings and instructions may result in electric shock, fire and/or serious injury. Save all warnings and instructions for future reference.



- This appliance is not intended for use by persons (including children) with reduced physical, sensory or mental capabilities, or lack of experience and knowledge, unless they have been given supervision or instruction concerning use of the appliance by a person responsible for their safety.
- Children should be supervised to ensure that they do not play with the appliance.

The device is designed only for the blowing of dry leaves in private households and as a hobby device in the garden. Any other utilization, which is not explicitly approved in these directions, can lead to damage to the device and represent a serious danger to the user.

- The device is designed for use by adults. Young people over 16 years may use the device under supervision only.
- The use of the device in the rain or in a humid environment is forbidden.
- The manufacturer is not liable for damage which is caused through inappropriate use or incorrect operation.

**Note:** Do not employ and low power machines for heavy work. DO NOT use your device for purposes for which it has not been designed.



**WARNING!** To reduce the risk of injury, user must read and understand instruction manual.

#### 1) General chain saw safety warnings:

**a) Keep all parts of the body away from the saw chain when the chain saw is operating. Before you start the chain saw, make sure the saw chain is not contacting anything.** *A moment of inattention while operating chain saws may cause entanglement of your clothing or body with the saw chain.*

**b) Always hold the chain saw with your right hand on the rear handle and your left hand on the front handle.** *Holding the chain saw with a reversed hand configuration increases the risk of personal injury and should never be done.*

**c) Hold the power tool by insulated gripping surfaces only, because the saw chain may contact hidden wiring.** *Saw chains contacting a "live" wire may make exposed metal parts of the power tool "live" and could give the operator an electric shock.*

**d) Wear safety glasses protection. Further protective equipment for hearing, head, hands, legs and feet is recommended.** *Adequate protective clothing will reduce personal injury by flying debris or accidental contact with the saw chain.*

**e) Do not operate a chain saw in a tree, on a ladder, from a rooftop, or any unstable support.** *Operation of a chain saw in this manner could result in serious personal injury.*

**f) Always keep proper footing and operate the chain saw only when standing on fixed, secure and level surface.** *Slippery or unstable surfaces may cause a loss of balance or control of the chain saw.*

**g) When cutting a limb that is under tension, be alert for spring back.** *When the tension in the wood fibres is released, the spring loaded limb may strike the operator and/or throw the chain saw out of control.*

**h) Use extreme caution when cutting brush and saplings.** *The slender material may catch the saw chain and be whipped toward you or pull you off balance.*

**i) Carry the chain saw by the front handle with the chain**

**saw switched off and away from your body. When transporting or storing the chain saw, always fit the guide bar cover.** *Proper handling of the chain saw will reduce the likelihood of accidental contact with the moving saw chain.*

**j) Follow instructions for lubricating, chain tensioning and changing the bar and chain.** *Improperly tensioned or lubricated chain may either break or increase the chance for kickback.*

**k) Cut wood only. Do not use chain saw for purposes not intended. For example: do not use chain saw for cutting metal, plastic, masonry or non-wood building materials.** *Use of the chain saw for operations different than intended could result in a hazardous situation.*

**l) Do not attempt to fell a tree until you have an understanding of the risks and how to avoid them.** *Serious injury could occur to the operator or bystanders while felling a tree.*

**m) Follow all instructions when clearing jammed material, storing or servicing the chain saw. Make sure the switch is off and the battery pack is removed.** *Unexpected actuation of the chain saw while clearing jammed material or servicing may result in serious personal injury.*

**n) Recommendation that the first-time user should, as a minimum, practise cutting logs on a saw-horse or cradle.**

**o) Recommendation to have sharpening and maintenance of the saw chain performed by authorised service centres.**

#### 2) Causes and operator prevention of kickback:

Kickback may occur when the nose or tip of the guide bar touches an object, or when the wood closes in and pinches the saw chain in the cut.

Tip contact in some cases may cause a sudden reverse reaction, kicking the guide bar up and back towards the operator. Pinching the saw chain along the top of the guide bar may push the guide bar rapidly back towards the operator.

Either of these reactions may cause you to lose control of the saw which could result in serious personal injury. Do not rely exclusively upon the safety devices built into your saw. As a chain saw user, you should take several steps to keep your cutting jobs free from accident or injury.

Kickback is the result of chain saw misuse and/or incorrect operating procedures or conditions and can be avoided by taking proper precautions as given below:

**a) Maintain a firm grip, with thumbs and fingers encircling the chain saw handles, with both hands on the saw and position your body and arm to allow you to resist kickback forces.** *Kickback forces can be controlled by the operator, if proper precautions are taken. Do not let go of the chain saw.*

**b) Do not overreach and do not cut above shoulder height.** *This helps prevent unintended tip contact and enables better control of the chain saw in unexpected situations.*

**c) Only use replacement bars and chains specified by the manufacturer.** *Incorrect replacement guide bars and saw chains may cause chain breakage and/or kickback.*

**d) Follow the manufacturer's sharpening and maintenance instructions for the saw chain.** *Decreasing the depth gauge height can lead to increased kickback.*

### 3) Instructions concerning the proper techniques for basic felling, limbing, and cross-cutting

#### 3.1 Felling a tree

When bucking and felling operations are being performed by two or more persons at the same time, the felling operations should be separated from the bucking operation by a distance of at least twice the height of the tree being felled. Trees should not be felled in a manner that would endanger any person, strike any utility line or cause any property damage. If the tree does make contact with any utility line, the company should be notified immediately.

The chain saw operator should keep on the uphill side of the terrain as the tree is likely to roll or slide downhill after it is felled.

An escape path should be planned and cleared as necessary before cuts are started. The escape path should extend back and diagonally to the rear of the expected line of fall as illustrated in Figure 1.

Before felling is started, consider the natural lean of the tree, the location of larger branches and the wind direction to judge which way the tree will fall.

Remove dirt, stones, loose bark, nails, staples and wire from the tree.

#### 3.2 Notching undercut

Make the notch 1/3 the diameter of the tree, perpendicular to the direction of falls as illustrated in Figure 1. Make the lower horizontal notching cut (W) first. This will help to avoid pinching either the saw chain or the guide bar when the second notch (X) is being made.

#### 3.3 Felling back cut

Make the felling back cut (Y) at least 50 mm higher than the horizontal notching cut as illustrated in Figure 1. Keep the felling back cut parallel to the horizontal notching cut. Make the felling back cut so enough wood is left to act as a hinge. The hinge wood keeps the tree from twisting and falling in the wrong direction. Do not cut through the hinge.

As the felling gets close to the hinge, the tree should begin to fall. If there is any chance that the tree may not fall in desired direction or it may rock back and bind the saw chain, stop cutting before the felling back cut is complete and use wedges of wood, plastic or aluminium (Z) to open the cut and drop the tree along the desired line of fall (3).

When the tree begins to fall remove the chain saw from the cut, stop the motor, put the chain saw down, then use the retreat path planned (2). Be alert for overhead limbs falling and watch your footing.

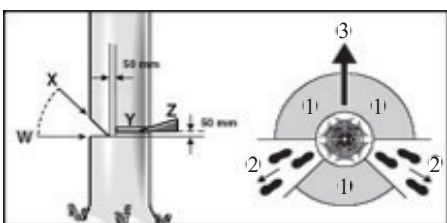

Figure 1

#### 3.4 Limbing a tree

Limbing is removing the branches from a fallen tree. When limbing leave larger lower limbs to support the log off the ground. Remove the small limbs in one cut as illustrated in Figure 2. Branches under tension should be cut from the bottom up to avoid binding the chain saw.

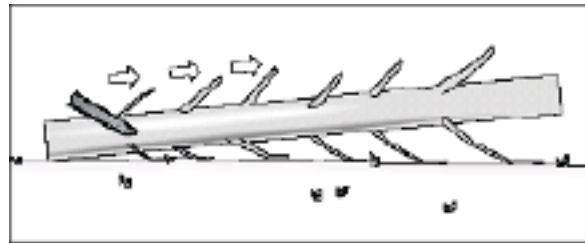

Figure 2

#### 3.5 Bucking a log

Bucking is cutting a log into lengths. It is important to make sure your footing is firm and your weight is evenly distributed on both feet. When possible, the log should be raised and supported by the use of limbs, logs or chocks. Follow the simple directions for easy cutting.

When the log is supported along its entire length as illustrated in Figure 3, it is cut from the top (overbuck), avoid contacting ground as this will greatly reduce the chain sharpness.

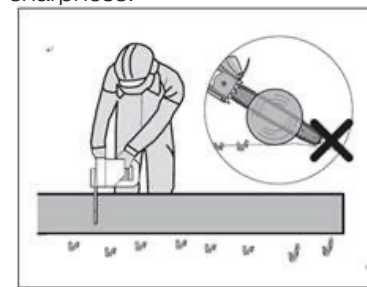

Figure 3

When the log is supported on one end, as illustrated in Figure 4, cut 1/3 the diameter from the underside (underbuck) (1). Then make the finished cut by overbucking (2) to meet the first cut.

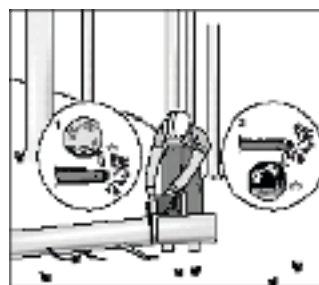

Figure 4

When the log is supported on both ends, as illustrated in Figure 5, cut 1/3 the diameter from the top (overbuck) (1). Then make the finished cut by underbucking (2) the lower 2/3 to meet the first cut.

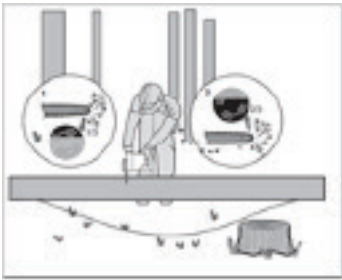

Figure 5

When bucking on a slope always stand on the uphill side of the log, as illustrated in Figure 6. When “cutting through”, to maintain complete control release the cutting pressure near the end of the cut without relaxing your grip on the chain saw handles. Don’t let the chain contact the ground. After completing the cut, wait for the saw chain to stop before you move the chain saw. Always stop the motor before moving from tree to tree.

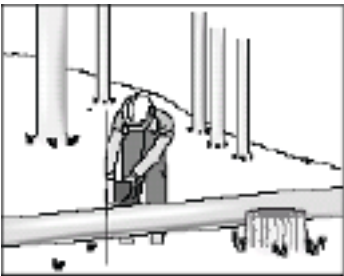
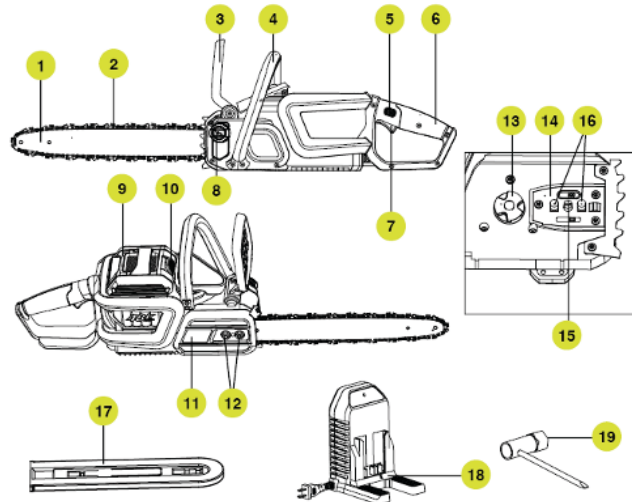

Figure 6

7. On/Off switch
8. Oil filler cap
9. Battery pack\*
10. Battery pack release button
11. Fastening nut for chain cover
12. Chain cover
13. Drive sprocket
14. Bar pad
15. Chain tensioning screw
16. Guide pins for chain bar
17. Blade protection cover
18. Charger\*
19. Chain tensioning wrench / Screwdriver



## Product Specifications

Product	Aerocore Turbo Chainsaw CCS60H.9
Rated Voltage	60V MAX
Bar Length	40cm (16")
Chain Speed	20m/s
Oil tank capacity	180ml
Chain Pitch	3/8"
Battery Capacity [553155 / ABP6025H]*	2.5 Ah
Battery Capacity [553156 / ABP6050H]*	5.0 Ah
Charger Input [553157 / ACG6025H]*	100-240V ~ 50/60Hz
Charger Output [553157 / ACG6025H]*	60V $\square$ 2.5 A
Charging Time (approx.)	1 hr
Charger protection class	II / III
Machine Weight	4.2kg (Chainsaw Only)

### Product Diagram

1. Guide Bar
2. Chain
3. Chain brake lever (Hand Guard)
4. Front handle
5. Lock off button
6. Rear handle

We recommend that you purchase your accessories from the same store that sold you the tool. Use good quality accessories marked with a well-known brand name. Choose the type according to the work you intend to undertake. Refer to the accessory packaging for further details. Store personnel can assist you and offer advice.

## Assembly

### CHAIN AND GUIDE BAR ASSEMBLY

1. Unpack all parts carefully.
2. Loosen the 2 nuts; take off the chain cover to expose the bar pad. (see Fig. A1, A2.)

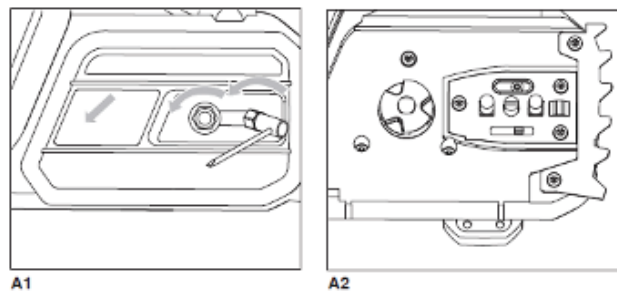

3. Place the chainsaw on a solid, level surface.
4. Slide the chain in the slot around the guide bar. Ensure the chain is in correct running direction by comparing it to the chain icon on the guide bar. (see Fig. A3.)





A3

**Warning:** Do not install the battery pack before it has been completely assembled. Always use gloves when handling the chain.

- Fit the chain onto the drive sprocket. Ensure the bar tensioning plate is facing outward. (see Fig. A4, A5.)
- Ensure all parts are seated properly. Make sure the drive links are fully seated in the drive sprocket (see Fig. A6.), avoid placing the chain in the inverse direction (see Fig. A7.) If kink occurs, pick up on the chain at the guide bar just ahead of the kink and then pull the kink out.

**NOTE:** Chain should rotate freely and be free of kinks.

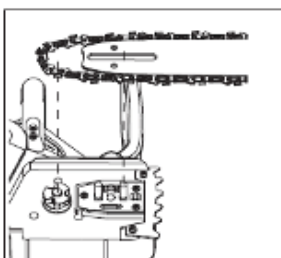

A4

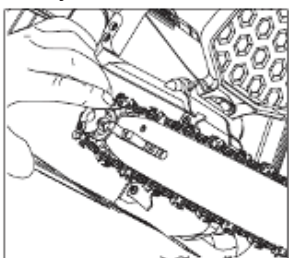

A5

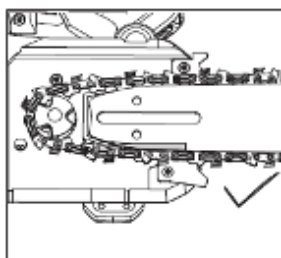

A6

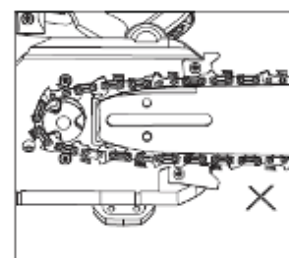

A7

- Tension the chain by tightening the chain tensioning screw (15) in clockwise direction using the supplied screwdriver. (see Fig. A8.) Do not overtighten.
- Press the chain cover onto the bar pad; screw the 2 nuts onto the guide pins for chain bar to lock the chain cover. (see Fig. A9.)
- If the chain is still loose, tension the chain by tightening the chain tensioning screw (15) using the supplied screwdriver (19). (see Fig. A10.)



A8

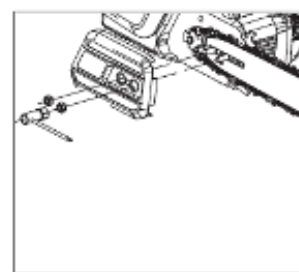

A9

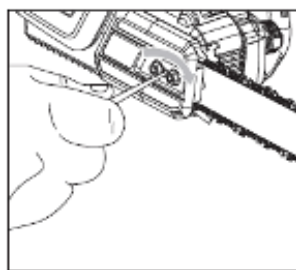

A10

### TENSIONING CHAIN AND BAR

**NOTE:** New saw chains will stretch. Check the chain tension frequently during first use, and tighten when the chain becomes loose around the guide bar.

### WARNING!

- Remove the battery pack before adjusting saw chain tension.
- Cutting edges on chain are sharp. Use protective gloves when handling chain.
- Maintain proper chain tension always. A loose chain will increase the risk of kickback. A loose chain may jump out of guide bar groove. This may injure operator and damage chain. A loose chain will cause chain, bar, and sprocket to wear rapidly.

### LUBRICATION

**NOTE:** Chain life and cutting capacity depend on optimum lubrication. Therefore, the chain is automatically oiled during operation.

- Set chainsaw on any suitable surface with oil filler cap facing upward.
- Clean area around the oil filler cap with a cloth, and unscrew the cap by turning it counter-clockwise.
- Add chain oil until tank is full.
- Avoid dirt or debris entering oil tank. Refit oil filler cap and tighten by turning clockwise until hand tight.

**It is important to use only the recommended bar and chain oil to avoid damage to the chainsaw. Never use recycled/old oil. Use of non-approved oil will void the warranty. Do not swallow. If swallowed, call a physician immediately. Keep out of reach of children. Store away from heat or open flame.**

### Checking the Automatic Oiler

Proper functioning of the automatic oiler can be checked by running the chainsaw and pointing the tip of the chain guide bar towards a piece of cardboard or paper on the ground. If an increasing oil pattern develops on the cardboard, the automatic oiler is operating fine. If there is no oil pattern, despite a full oil reservoir, contact the customer service agent or a CTC-approved service agent.



**⚠ WARNING!**

- The chainsaw is not filled with oil. It is essential to fill with oil before use. Never operate the chainsaw without chain oil or at an empty oil tank level, as this will result in extensive damage to the product.
- Remove the battery pack before filling the oil tank.
- To allow proper ventilation of the oil tank, small breather channels are provided between the oil filler cap and the strainer to prevent leakage. Ensure machine is left in a horizontal position when not in use.
- Do not touch the ground with the chain. Ensure safety clearance of 12" (30 cm).

## Operation

### BEFORE PUTTING INTO OPERATION

#### 1. CHARGING THE BATTERY (SEE FIG. B)

- The battery in your new tool is not charged when it leaves the plant; therefore, it must be full charged before using the first time.
- If the battery pack is very hot, remove the battery from the charger and allow it to cool to ambient temperature before attempting to recharge.
- To prevent damage to the battery pack, please charge the battery to full or no less than half charge before storage.
- If the tool will not be used for long periods of time, charge the battery pack every 3-6 months.

### CHARGING PROCEDURE

- 1) Plug the charger into an appropriate outlet.
- 2) Slide the battery pack into the charger, and make sure the battery is in the correct charge position firmly. The light will begin flashing green to indicate the charging process has started.
- 3) When charging is completed, the light will turn solid green.
- 4) After the battery is fully charged, unplug the charger and remove the battery pack.

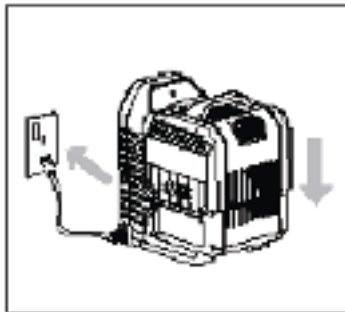

**NOTE:** If the battery pack is locked in the charger, press the battery pack release button and remove it.













**⚠ Warning!** The charger and battery pack are specially designed to work together so do not attempt to use any other devices. Never insert or allow metallic objects into your charger or battery pack connections because an electrical failure and hazard will occur.

**⚠ WARNING:** When battery charge runs out after continuous use or exposure to direct sunlight or heat, allow time for the tool to cool down before re-charging to achieve the full charge.

### CHARGING INDICATOR

This charger is designed to detect some problems that can

arise with battery packs. Indicator lights indicate problems (see table below).

Light	ON/Flash	Status
Red on  		Defective Battery
Red flash  		Battery Temperature Protection. The temperature of the battery pack is less than 0°C or more than 40°C.
Green on  		Fully Charged
Green flash  		Charging

### 2. TO REMOVE OR INSTALL BATTERY PACK (SEE FIG. C)

#### 2.1) REMOVING

Depress the battery pack release button firmly first and then lift the battery pack up to remove from your tool.

#### 2.2) INSTALLING

Place the fully charged battery pack into the tool until it clicks into position.

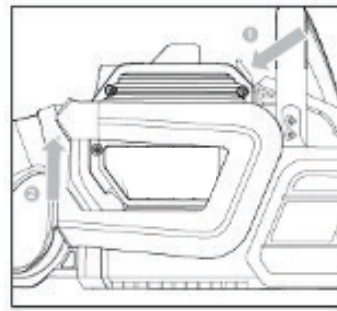

C

### 3. SWITCHING ON AND OFF

To switch on the tool, first engage the chain brake by pulling the guard toward the auxiliary handle as demonstrated in Fig. D1. The chainsaw guard will move from position 2 to position 1, referenced in Fig. D3, once the chain brake is engaged. Press the lock-off button, then fully press the on/off switch and hold in this position. The lock-off button can now be released. (see Fig. D2.)

To switch off, release the on/off switch, or push the hand guard into position 2 as shown in D3. For more details, please refer to THE CHAIN BRAKE section.

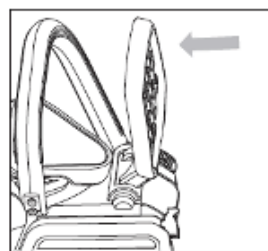

D1

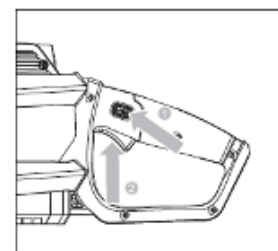

D2

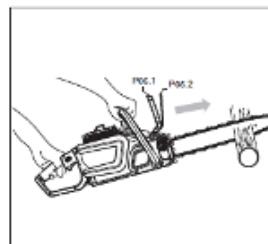

D3

**WARNING!** The battery pack will be too cold to be used if it has been left in the environment with too low temperature (less than -20 degrees Celsius) for a long time. The battery pack needs to be warmed up before use.

#### How to use Saw Safely

- 3.1. Use the chainsaw only with secure footing.
- 3.2. Hold the chainsaw at the right-hand side of your body. (see Fig. E.)

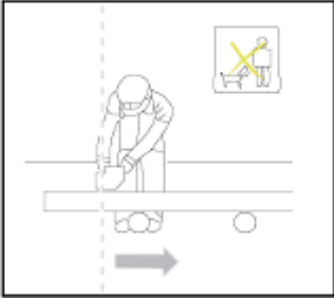

- 3.3. The chain must be running at full speed before it makes contact with the wood.
- 3.4. Do not operate the chainsaw with arms fully extended, attempt to saw areas which are difficult to reach, or stand on a ladder while sawing. (see Fig. F.)

**Never use the chainsaw above shoulder height.**

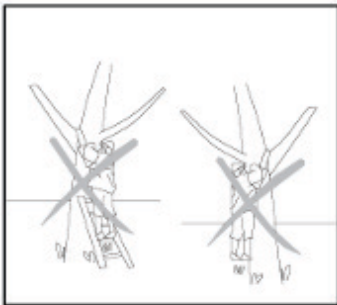

#### 4. THE CHAIN BRAKE (See Fig. G)

The chain brake lever is a safety mechanism activated through the front hand guard when kickback occurs. The chain stops immediately.

The following function check should be carried out at regular intervals.

- 4.1. Manual chain brake: push front hand guard forward (position 2) and try starting the chainsaw. The chainsaw must not start. To deactivate the kickback brake, pull hand guard backwards (position 1), and release on/off switch. (See component list for switch on and off locations.)
- 4.2. Automatic chain brake: release the on/off switch to activate chain brake automatically.

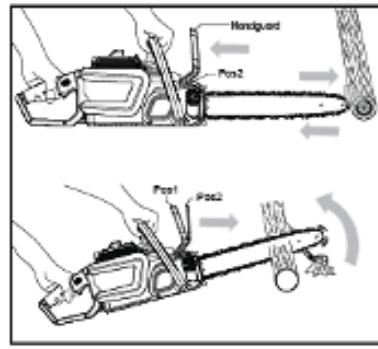

G

#### 5. CUTTING

- 5.1. Install the battery pack into the machine.
- 5.2. Make sure section of log to be cut is not laying on the ground. This will keep the chain from touching the ground as it cuts through the log. Touching the ground while the chain is moving is dangerous and will dull the chain.
- 5.3. Use both hands to grip saw. Always use left hand to grip front handle and right hand to grip rear handle. Use a firm grip. Thumbs and fingers must wrap around saw handles. (See Fig. H.)

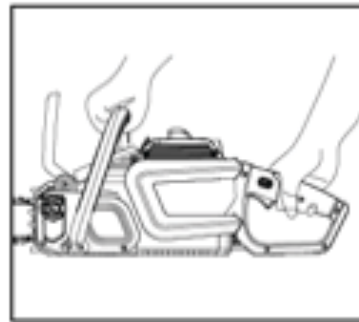

H

- 5.4. Make sure your footing is firm. Keep feet shoulder-width apart. Distribute your weight evenly on both feet.
- 5.5. When ready to make a cut, push the lock-out button completely in with the right thumb and squeeze the trigger. This will turn saw on. Releasing the trigger will turn the saw off. Make sure the saw is running at full speed before starting a cut.
- 5.6. When starting a cut, slowly place moving chain against the wood. The wood should be as close to the saw body as possible. Hold saw firmly in place to avoid possible bouncing or skating (sideways movement) of saw.
- 5.7. Guide the saw using light pressure and do not put excessive force on the saw, letting the saw do its work. Excessive force can cause the motor to overload and burn out. It will do the job better and safer at the rate for which it was intended.
- 5.8. Remove the saw from a cut with the saw running at full speed. Stop the saw by releasing the on/off switch. Make sure the chain has stopped before setting the saw down.
- 5.9. Keep practicing on scrap logs in a secure working area until you are comfortable, using a fluid motion and a steady cutting rate.

#### Kickback Safety Devices On This Saw

This saw has a low-kickback chain and reduced kickback guide bar. Both items reduce the chance of kickback. However, kickback can still occur with this saw. The following steps will reduce the risk of kickback.

- Use both hands to grip saw while saw is running. Use a firm grip. Thumbs and fingers must wrap around saw handles.
- Keep all safety items in place on saw. Make sure they work properly.
- Do not overreach or cut above shoulder height.
- Keep solid footing and balance at all times.
- Stand slightly to the left side of saw. This keeps your body from being in direct line with chain.
- Do not let the guide bar nose touch anything when chain is moving.
- Never try cutting through two logs at same time. Only cut one log at a time.
- Do not bury the guide bar nose or try plunge cut (boring into wood using guide bar nose).
- Watch for shifting of wood or other forces that may pinch chain.
- Use extreme caution when reentering a previous cut.
- Use only the low-kickback chain and guide bar that were supplied with this chainsaw or recommended.
- Never use a dull or loose chain. Keep chain sharp with proper tension.

- Saw has to be forced through the cut.
- Inadequate supply of oil to the bar and chain. Check the condition of the guide bar each time the chain is sharpened. A worn guide bar will damage the chain and make cutting difficult. After each use, remove the battery pack, and clean all sawdust from the guide bar and sprocket hole.

When rail top is uneven, use a flat file to restore square edges and sides.

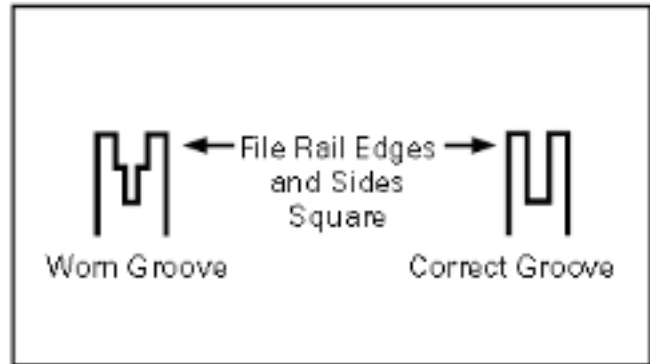

Replace the guide bar when the groove is worn, the guide bar is bent or cracked, or when excessive heating or burring of the rails occurs. If replacement is necessary, use only the guide bar specified for your saw in the repair parts list or on the decal located on the chainsaw.

## Maintenance

### Saw Maintenance

Follow maintenance instructions in this manual. Proper cleaning of saw and chain and guide bar maintenance can reduce chances of kickback. Inspect and maintain saw after each use. This will increase the service life of your saw. Note: Even with proper sharpening, risk of kickback can increase with each sharpening.

### Bar Maintenance

To maximize bar life, the following bar maintenance is recommended.

The bar rails that carry the chain should be cleaned before storing the tool or if the bar or chain appear to be dirty. The rails should be cleaned every time the chain is removed.

### To Clean the Bar Rails

1. Remove chain cover and bar and chain. (See section ASSEMBLY.)
2. Using a wire brush, screwdriver or similar tool, clear the residue from the inner groove of the bar. (see Fig. I.)
3. Make sure to clean oil passages thoroughly

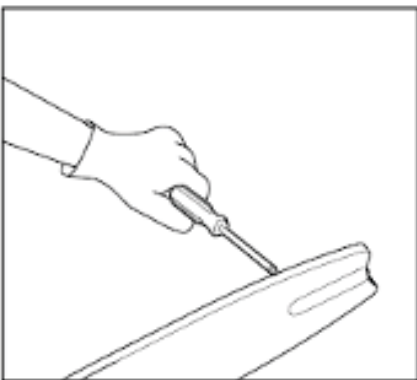

Conditions which require chain and guide bar maintenance:

- Saw cuts to one side or at an angle.

### Replacing Bar and Chain

Replace chain when cutters are too worn to sharpen or when chain stops. Only use replacement chain noted in this manual.

Inspect guide bar before sharpening chain. A worn or damaged guide bar is unsafe. A worn or damaged guide bar will damage chain. It will also make cutting harder.

### Sharpening the Saw Chain

**Cutting edges on chain are sharp. Use protective gloves when handling chain.**

Keep chain sharp. Your saw will cut faster and more safely. A dull chain will cause undue sprocket, guide bar, chain, and motor wear. If you must force chain into wood, and cutting creates only sawdust with few large chips, the chain is dull.

### NOTE:

**It is not necessary to remove the chain or bar when lubricating the guide bar sprocket.**

1. Clean the bar and sprocket.
2. Using a grease gun, insert the tip of the gun into the lubrication hole and inject grease until it appears at the outside edge of the sprocket tip. (see Fig. J.)
3. To rotate the sprocket, pull the chain by hand until the ungreased side of the sprocket is in line with the grease hole. Repeat the lubrication procedure.



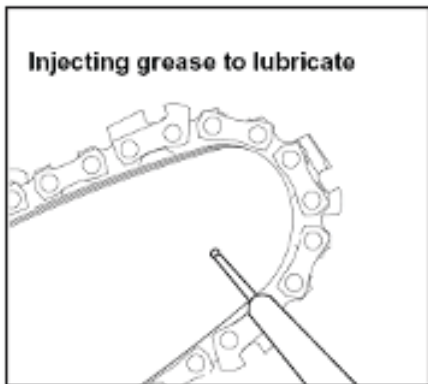

J

### Warning:

- Remove the battery pack before servicing. Severe injury or death could occur from electric shock or body contact with moving chain.
  - Wear heavy-duty gloves when performing any maintenance or service to this tool.
- Always remove the battery pack before performing any service or maintenance on this tool.

Remove the battery pack. Disassemble the chainsaw by removing the bar and the chain. Store the chainsaw, the battery pack and the accessories indoors in a cool, dry, clean place which is protected from the effects of weather and temperature and is out of the reach of children and animals.

## Storage

### MAINTENANCE AND STORAGE OF THE CHAINSAW

#### 1. Remove the battery pack

- When not in use.
- Before moving from one place to another.
- Before servicing.
- Before changing accessories or attachments, such as saw chain and guard.

2. Inspect chainsaw before and after each use. Check saw closely if guard or other part has been damaged. Check for any damage that may affect operator safety or operation of saw. Check for alignment or binding of moving parts. Check for broken or damaged parts. Do not use chainsaw if damage affects safety or operation. Have damage repaired by authorized service center.

#### 3. Maintain chainsaw with centre.

- Never expose saw to rain or direct moisture.
- Keep chain sharp, clean, and lubricated for better and safer performance.
- Follow steps outlined in this manual to sharpen chain.
- Keep handles dry, clean, and free of oil and grease.
- Keep all screws and nuts tight.

#### 4. When servicing, use only identical replacement parts.

#### 5. When not in use, always store chainsaw

- In a high or locked place, out of children's reach.

- In a dry place.
- With bar and chain cover in place.

6. It is recommended that the battery be stored indoors for the winter months.

### For Battery and Charger

The ambient temperature range for the use and storage of the charger and battery is 0 – 45°C (32 – 113°F).

The recommended ambient temperature range for the charging system during charging is 0 – 40°C (32 – 104°F).

It is recommended that the battery be stored indoors for the winter months.

## Troubleshooting

The following table gives checks and actions that you can perform if your machine does not operate correctly. If these do not identify/remedy the problem, contact your service agent.

 **WARNING:** Switch off and remove the battery pack before investigating fault.

Symptom	Possible Causes	Solution
Chainsaw fails to operate.	Low battery charge. Chain brake not in the proper position.	Charge battery packs. Check to see if the chain brake is in position. Refer to THE CHAIN BRAKE section for details.
Chainsaw operates intermittently.	Over heating. Applying too much pressure while cutting. Loose connection. Internal wiring defective. On/Off switch defective	Place the machine in a cool, ventilated place to cool it down.  Applying relatively less pressure while cutting. Contact Masport service agent.
Dry chain.	No oil in reservoir. Vent in oil filler cap clogged. Oil passage clogged.	Refill oil. Clean cap. Clean oil passage outlet.
Brake does not stop chain.	Run-down kickback brake.	Contact Masport service agent.
Chain/ Chain bar overheats	No oil in reservoir. Vent in oil filler cap clogged. Chain is over tensioned. Dull chain.	Refill oil. Clean cap. Clean oil passage outlet. Adjust chain tension. Sharpen chain or replace.
Chainsaw rips, vibrates, does not saw properly.	Chain tension too loose. Dull chain. Chain worn out. Chain teeth are facing in the	Adjust chain tension. Sharpen chain or replace. Replace chain. Reassemble with chain in correct direction.

### Masport Ltd

320 Ti Rakau Drive, East Tamaki, Auckland 2013

New Zealand

P.O.Box 14 349, Panmure, Auckland 1741